



Stretta Countertops – Installation Made Easy

With Stretta's patented installation process, installing a countertop has never been faster or easier!

IMPORTANT INFORMATION PRIOR TO INSTALLATION

- **CAUTION: Stretta should be lifted by two people to avoid injury or damage during installation.**
- For Indoor Installation Only
- Store your countertop upright in a dry, climate-controlled environment free from excessive humidity.
- Backsplash installation is optional, and in some instances, the backsplash must be purchased separately.
- To finish the ends of your countertop a Stretta endcap kit is required and, in some instances, must be purchased separately.
- Proper carrying and handling of Stretta countertops is imperative to prevent damage. Always carry the Stretta countertops vertically as shown on page two.

IMPORTANT INFORMATION DURING INSTALLATION

- Wear safety equipment during the installation process.
- The Stretta Installation kit is only necessary to join the Londoner A and B countertops.
- Backsplash installation is optional.

IMPORTANT INFORMATION AFTER INSTALLATION

- For everyday cleaning use a clean, damp, non-abrasive cloth with a mild detergent or household cleaner.
- To remove stuck-on residue, scrub with a nylon-bristled brush.
- Do not use cleaners containing acid, alkali, or bleach.
- Do not place hot items directly on your Stretta countertop.
- Do not allow liquids to pool on the surface of your Stretta countertop.
- Do not use your Stretta countertop as a cutting board or slide abrasive items across your Stretta countertop.

INSTALLATION KIT CONTAINS:

Stretta™

Note: Installation kit only required for Londoner A/B countertop applications.



4 Wood Biscuits



1 Pack
Adhesive



3 Specialty
Screws



1 Specialty
Screw Bit

TOOLS REQUIRED:

Stretta™

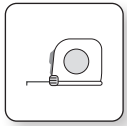

Measuring Tape

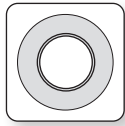

Painter's Tape



Pencil



220 Grit Sandpaper



Utility Scissors

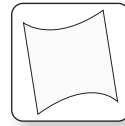

Cotton Cloth

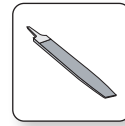

Fine Wood File

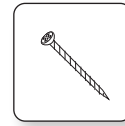

Wood Screws

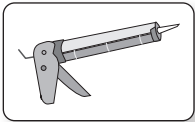

Silicone Sealant & Gun

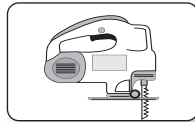

Jigsaw with Laminate Cutting Blade

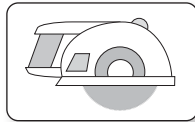

Circular Saw (36 volt) with 140 Tooth Plywood Saw Blade

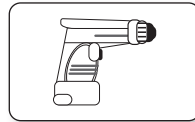

Drill (18 volt)

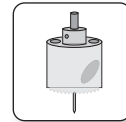

Multi Material Hole Saw (with pilot bit)



Saw Horses

OPTIONAL BACKSPLASH INSTALLATION TOOLS:

Stretta™

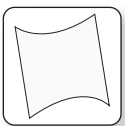

Cotton Cloth

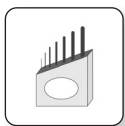

Wood Screws

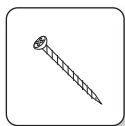

Wood Screws

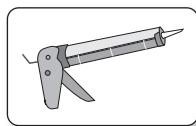

Silicone Sealant & Gun

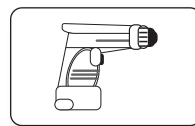

Drill (18 volt)

SAFETY:

Stretta™



Safety Glasses



Dust Mask



Ear Protection

PROPER CARRYING & HANDLING:

Stretta™

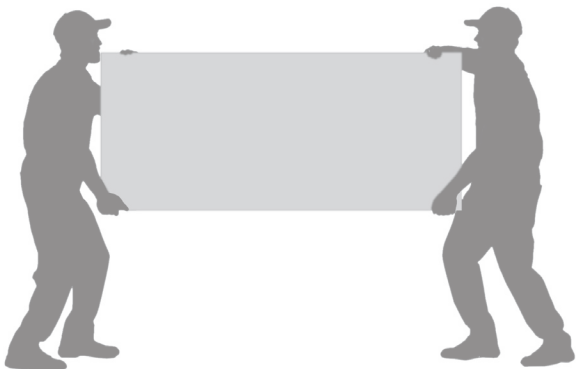

STEP 1 - TEST FIT

Stretta™

Place Stretta countertop(s) on installed base cabinetry to test fit the tops and to determine if you need to modify the length of the countertop(s). Standard overhang for exposed ends is $\frac{1}{2}$ " (Figure 1-1) while those that meet a wall or appliance have no overhang and fit flush. Prior to cutting the countertop to length, apply painter's masking tape to the cut line to ensure a smooth cut. Flip the countertop over to cut to length, making sure the teeth of the saw enter the bottom surface of the countertop starting at the front edge of the countertop and cutting toward the back edge. (Figure 1-2)

PRO TIP: Avoid using excess force or speed while cutting, as this can cause the saw to bind which may result in damage.

NOTE: The following instructions are for a corner installation to join the Londoner A and B. If you do not have a corner installation, for additional information see Step 3.

Before installing, test fit the Londoner® joint (Figure 1-3) to make sure it comes together tightly. If necessary, sand with 220 grit sandpaper to remove any rough or irregular areas of the substrate.

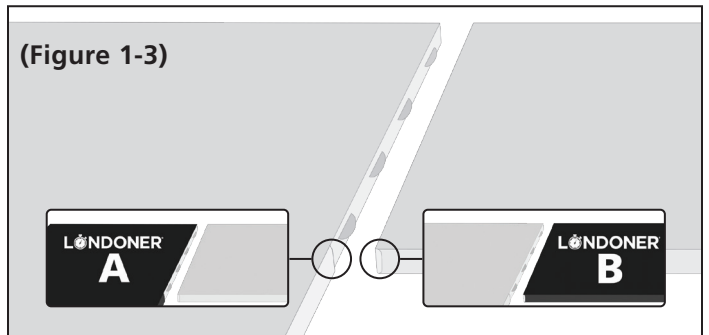
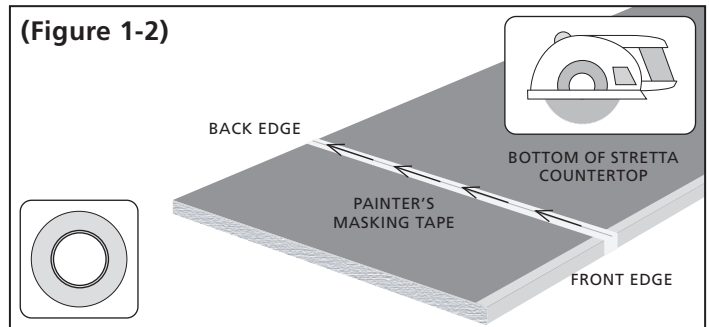
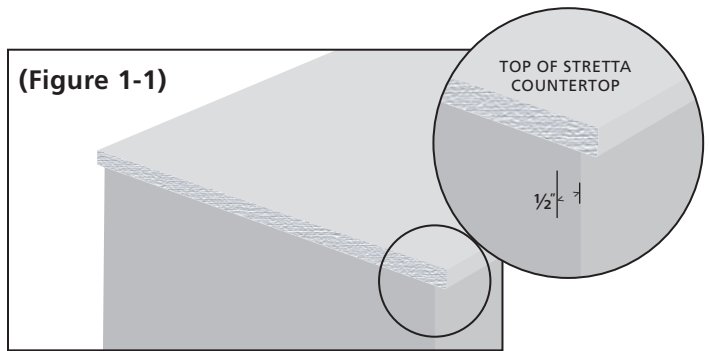

STEP 2 - ENDCAP INSTALLATION

Stretta™

NOTE: To finish the ends of your countertop a Stretta endcap kit is required and, in some instances, must be purchased separately.

Remove endcaps from packaging and test fit them to the exposed ends of the countertop to make sure they cover the ends. (Figure 2-1) If you need to finish the ends of the backsplash, cut 4" off each endcap with the utility scissors and set the 4" pieces aside. (Figure 2-2) Lightly sand the exposed ends of the countertop with 220 grit sandpaper to remove any loose particles or debris.

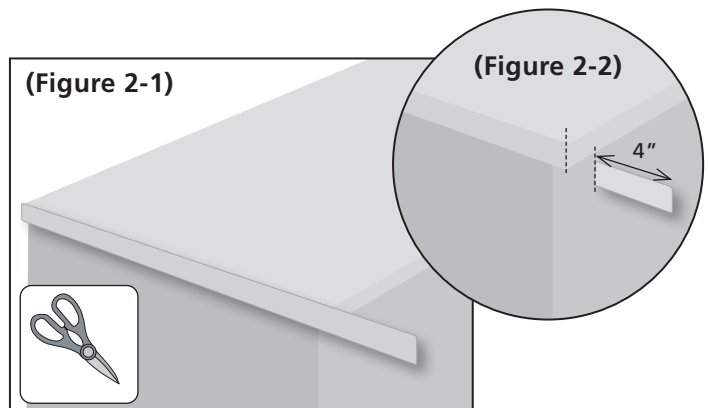

Continue Step 2 on next page

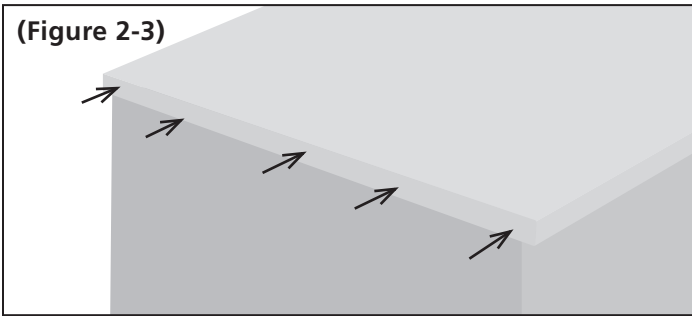

Once the endcap is applied, using utility scissors, trim off as much of the excel material as possible. (Figure 2-4) Then facing the endcap, use a fine file and safety glasses, place the file nearly parallel to the counter. File in a single-direction movement towards the countertop, always from front to back, (Figure 2-5) until there is no excess material and the endcap is flush with the end of the countertop.

PRO TIP: Apply painter's masking tape to countertop surface and cabinetry to protect the surfaces while filing. (Figure 2-6)

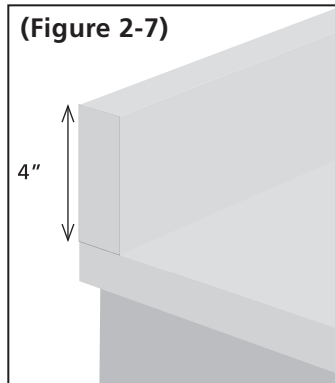
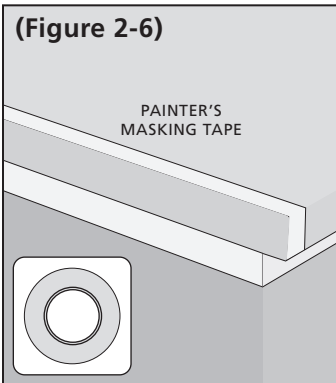

Remove the paper backing on the endcap to expose the adhesive. Line the endcap up with the end of the countertop so that it is flush with the front edge and top of the countertop surface. (Figure 2-3) With your hand, press the endcap firmly against the end of the countertop to activate the adhesive.

CAUTION: Take care to properly position the endcap, as it is difficult to reposition the endcaps after the adhesive has set.

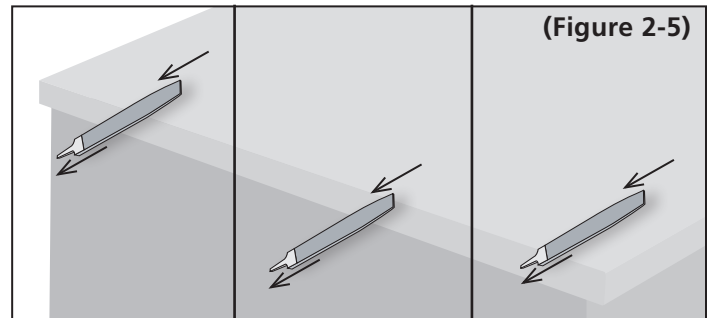
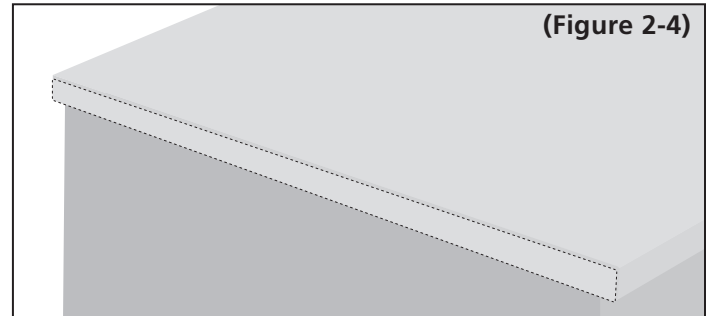

If needed, to finish the end(s) of your backsplash, locate the 4" pieces of endcap material. (Figure 2-7) First, sand the exposed end(s) of the backsplash with 220 grit sandpaper to remove any loose particles or debris. Follow steps noted in (Figure 2-2) through (Figure 2-5).

STEP 3 - CONNECTING THE LONDONERS

Stretta™

Install 4 biscuits into one side of the countertop. (Figure 3-1) Apply a generous amount of adhesive to both sides of the Londoner joint and the biscuits, so that when the countertops are joined together, the excess glue is

squeezed out. Pull countertops together. (Figure 3-2) Allow the glue to cure for five minutes prior to removing the excess with warm water and a cotton cloth.

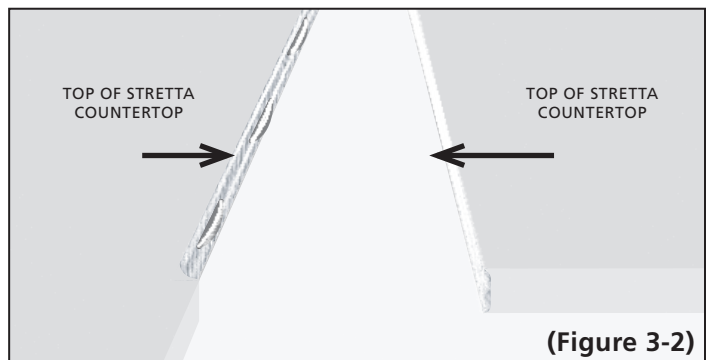
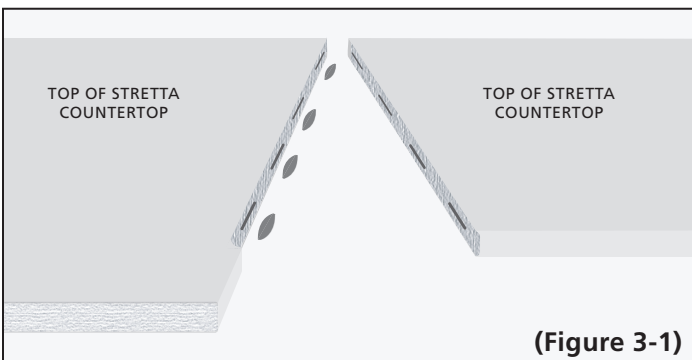

STEP 4 - SECURE TO CABINETRY

Stretta™

Slide the countertops away from the wall slightly to access the pockets on the underside of the countertop. Drive the three specialty screws into the pockets using the specialty screw bit included in the Stretta Installation Kit. Two screw pockets are located on the bottom side of the countertop (Figure 4-1) and one is

located on the back side of the countertop. (Figure 4-2) You can now attach your countertop to the cabinets by driving screws (not included) through the cabinet corner mounting brackets into the countertop. (Figure 4-3)

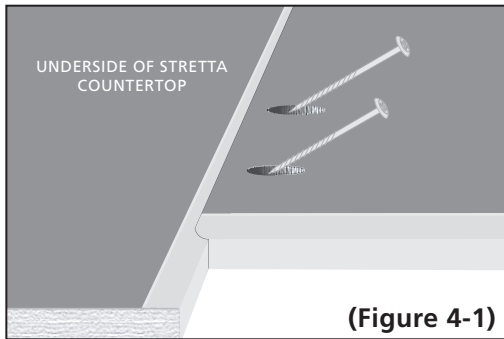

(Figure 4-1)

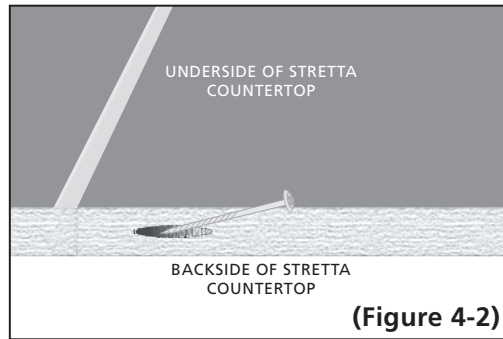

(Figure 4-2)

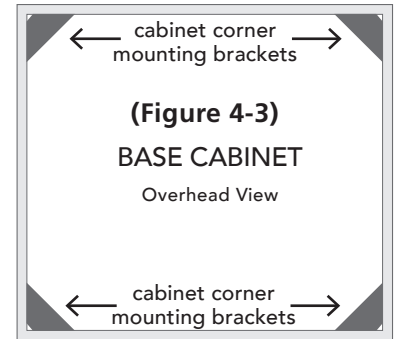

If the countertop overhangs the cabinet by less than 8 inches additional support is not needed. For an overhang more than 8 inches, support brackets or corbels will be required every 24 inches. (Figure 4-4)

CAUTION: Do not use screws that exceed the combined thickness of the corner mounting bracket and the thickness of the Stretta countertop, otherwise you risk surface penetration. (Figure 4-5)

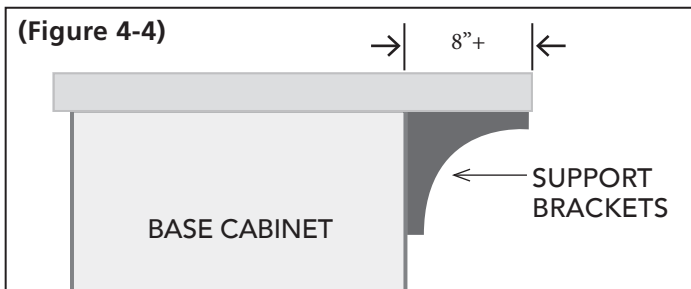

(Figure 4-4)

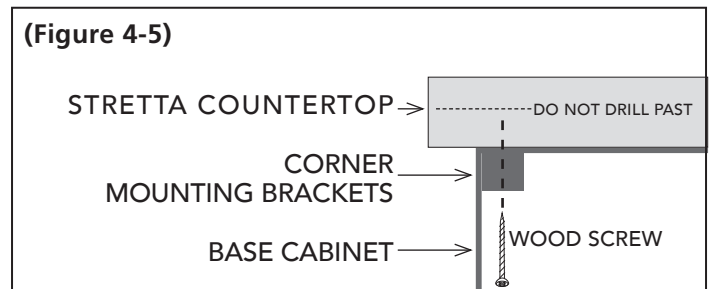

(Figure 4-5)

STEP 5 - DROP-IN SINK INSTALLATION

Stretta™

Using the sink template and a pencil, trace the outline of the sink in the desired location. If using the sink to draw the outline, be sure to draw a cutting line 1/2" inside the sink outline. (Figure 5-1)

PRO TIP: Once the drill bit extends through the surface of the countertop, finish cutting the hole with the hole saw from the bottom side of the countertop.

Using the hole saw and drill, make a hole 1/4" inside the cutout. (Figure 5-2)

Next, set the angle of your jig saw laminate cutting blade to 3 and start cutting from the hole along the cutout line, making sure the corners are slightly rounded. (Figure 5-3)

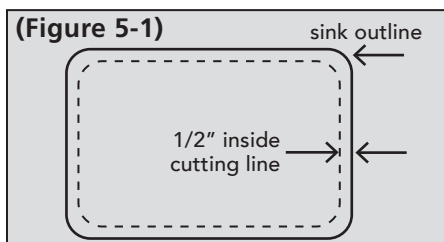

(Figure 5-1)

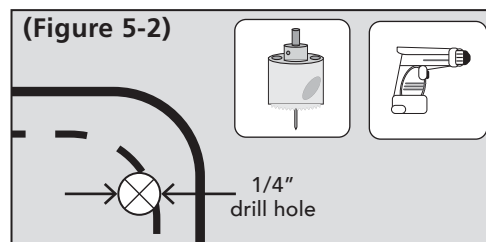

(Figure 5-2)

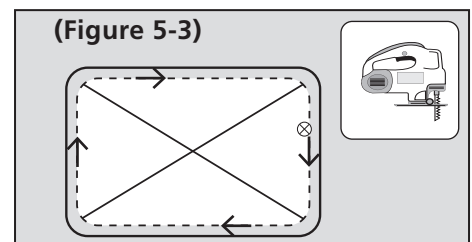

(Figure 5-3)

Apply a silicone sealant around the cut out, insert the sink pressing firmly, and wipe off the excess.

NOTE: Stretta backsplash installation is optional, and, in some instances, must be purchased separately.

Cut backsplash to size using circular saw and painter's masking tape.

To achieve a perfect bond, it is important to wipe down the backsplash and surface of your Stretta countertop with a dry cotton cloth to remove any loose particles or debris. **(Figure 6-1)**

Apply construction adhesive to the back and bottom surfaces of the backsplash. **(Figure 6-2)**

Set the backsplash in place and apply pressure so that the excess construction adhesive is squeezed out. **(Figure 6-3)** Clean up the excess construction adhesive immediately with warm water and a cotton cloth.

Due to variances in wall straightness, you may need to take additional measures to secure your Stretta backsplash. To further secure your backsplash to the countertop, first drill pilot holes every 12 inches through the underside of the countertop and into the backsplash to prevent splitting. **(Figure 6-4)**

Then, using wood screws; screw into the pilot holes while holding the backsplash in place. **(Figure 6-5)**

CAUTION: Take care when pre-drilling the pilot holes and screws so that the bit or screw enters straight into the surfaces and not at an angle, otherwise you risk surface penetration.

